



1 M	2 M	5 M															
10.8	21.3	48.0															

**Test items 测试项目**

**Appearance 外观检验**

**Dimension 尺寸检验**

Check qty 检验数量:

1

Result 结果:

PASS

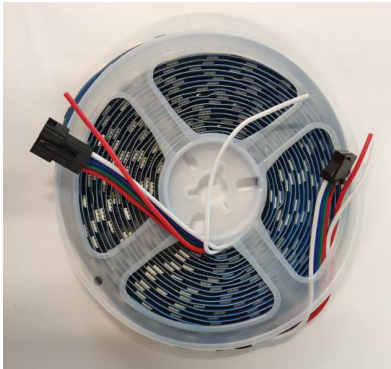

Check qty 检验数量:

1

Result 结果:

PASS

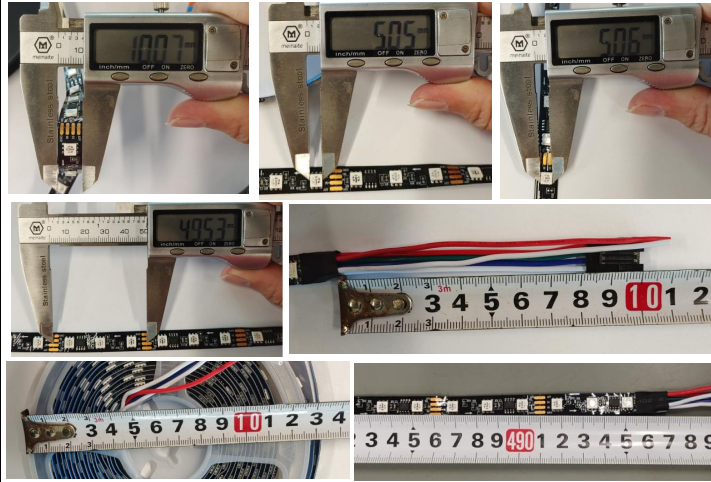

**IP Test 防水测试**

**Spectrum 积分球测试**

Check qty 检验数量:

Result 结果:

N/A

Check qty 检验数量:

1

Result 结果:

PASS

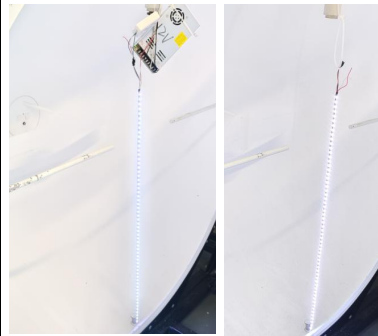

Detail refer to spectrum testing report.

**Photometric test IES光分布测试**

**Safety -Insulation test 绝缘阻抗测试**

Check qty 检验数量:

Result 结果:

Check qty 检验数量:

1

Result 结果:

PASS

N/A

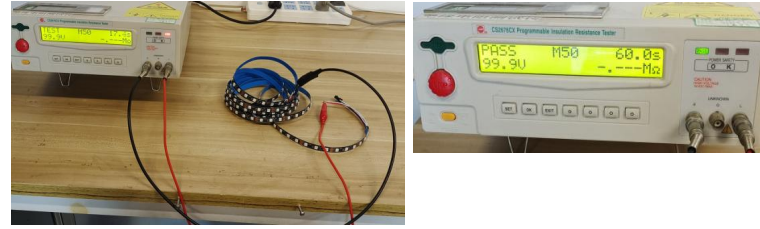

**Pull test 拉力测试**

Check qty 检验数量 :

1

Result 结果:

PASS

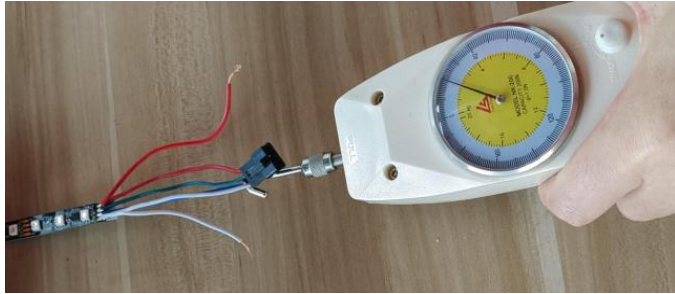

**Lighting and switch test 点亮和开关测试**

Check qty 检验数量 :

1

Result 结果:

PASS



**Aging Test 老化测试**

Check qty 检验数量 :

1

Result 结果:

PASS



**Thermal test 温升测试**

Check qty 检验数量 :

1

Result 结果:

PASS

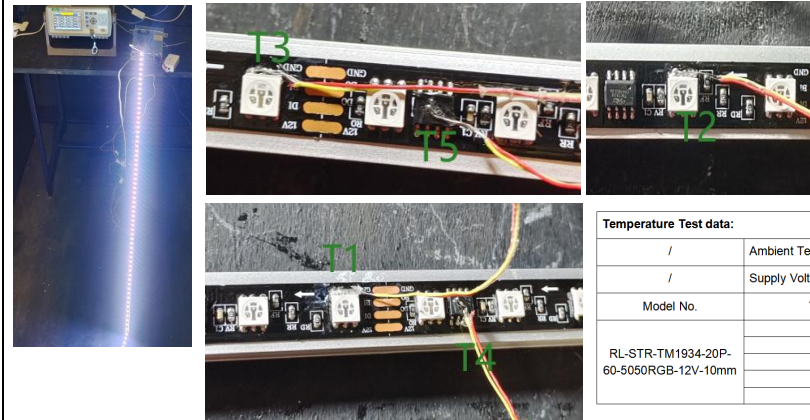

Temperature Test data:		
/	Ambient Temperature: 25 °C	Relative Humidity: 66%
/	Supply Voltage: 12V	Type of Thermocouples: K
Model No.	Test Point	Test Result
RL-STR-TM1934-20P-60-5050RGB-12V-10mm	T1	45.2
	T2	46.6
	T3	43.1
	T4	49.5
	T5	46.7

**Workmanship & PCBA check 工艺和PCBA检查**

Test qty 测试数量 :

1

Result 结果:

PASS

**Packing inspection 包装检查**

Test qty 测试数量 :

Result 结果:

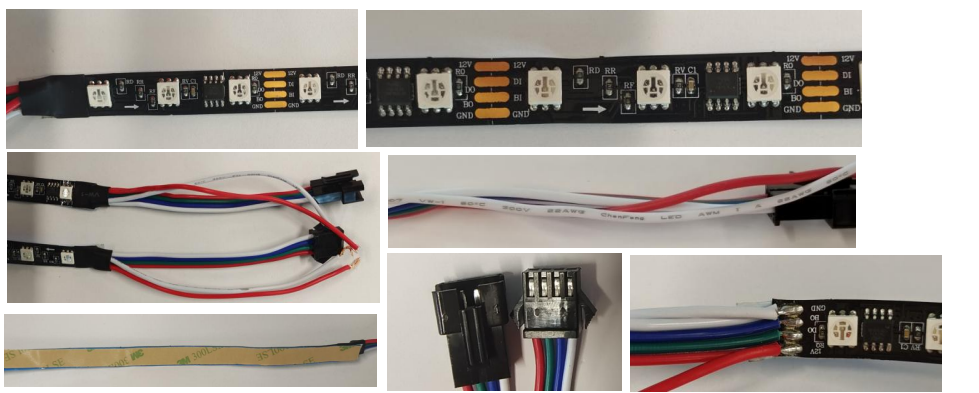

N/A

**Rubbing Test 标签擦拭测试**

**Other special test/check 其他特别检查**

Test qty 测试数量 :

Result 结果:

Test qty 测试数量 :

Result 结果:

N/A

N/A